

SG 6243

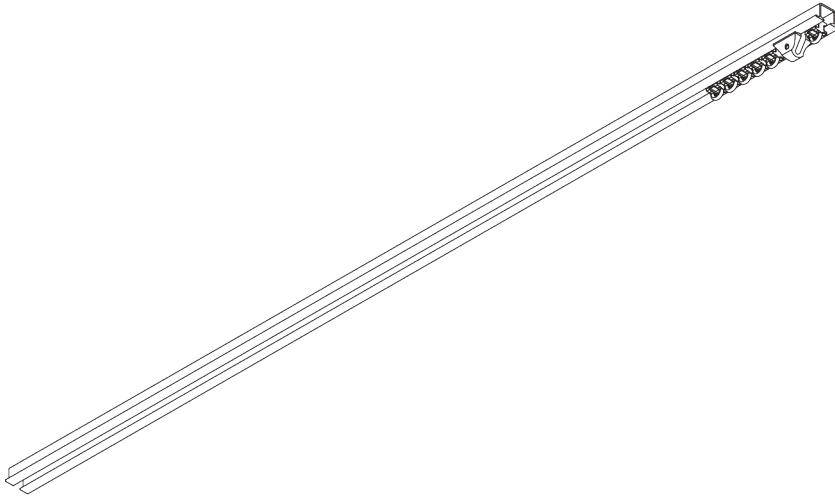
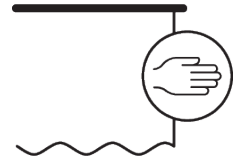

PRODUCT INFORMATION

- **Operation:** hand
- **Range:** S - M
- **Fitting:** recess
- **Colours:** white RAL 9016; special colours

Features:

- 2-component (2C) glider technology
- Wave (2C)
- Bendable
- Pre-drilled profile

SYSTEM SPECIFICATIONS

A. PROFILE

Profile and bending information

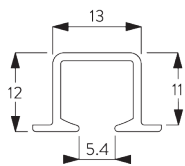

SG 6243p

Profile

Radius:
20 cm, >25 cm

B. HOW TO MEASURE

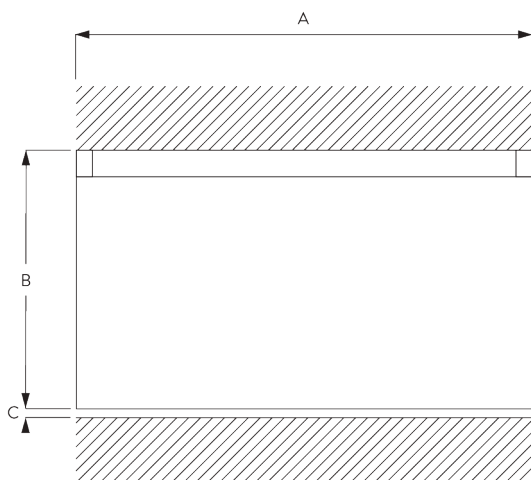

A: System width
B: System height
C: Distance between floor and fabric

C. SPECIFICATION TEXT

Silent Gliss SG 6243 Hand Operated Curtain Track System. Comprises aluminium profile SG 6243 supplied made to measure powder coated white with gliders SG 11300 at 16/m, 1 end stop SG 11295 and 1 spring stop SG 6053 per length. Top fixed with screw SG 0240 into timber through pre drilled holes every 200mm.

FITTING

A. FITTING INFORMATION

Fixing points

For detailed fitting information, visit the [Silent Gliss website](#).

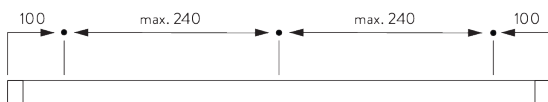

B. RECESS FITTING

Direct into wood

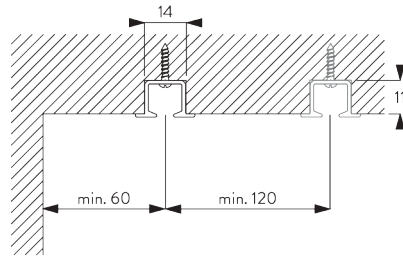

Recess channel: 11 x 14 mm

SYSTEM OPTIONS

A. WAVE

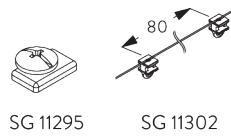
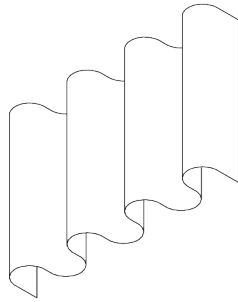

SG 11295

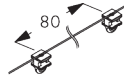

SG 11302

Standard components:

- SG 11295 End stop
- SG 11302 Wave 2C glider cord 80 mm

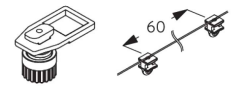

SG 2256

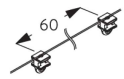

SG 11303

Optional components (min. radius >25 cm):

- SG 2256 Brake
- SG 11303 Wave 2C glider cord 60 mm

Curtain components:

- SG 3582 Hook
- SG 6349 Wave curtain tape

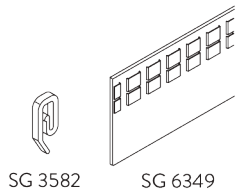

Wave stack depth - 2C glider cord (standard components)

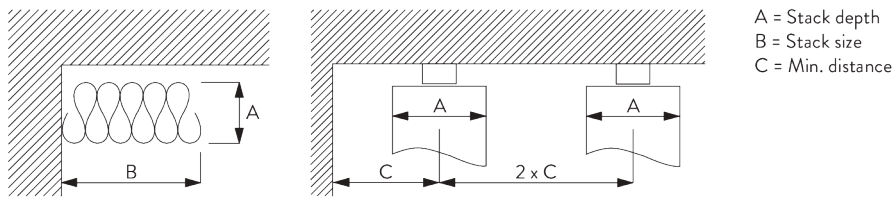

A = Stack depth
 B = Stack size
 C = Min. distance

2C Glider cord SG 11302	Pockets between hooks	Approx. curtain fullness	Stack depth A	Stack size B*	Min distance C
80	6	~2.1	140	180 per metre of track	90
80	7	~2.3	160	180 per metre of track	100

2C Glider cord SG 11303	Pockets between hooks	Approx. curtain fullness	Stack depth A	Stack size B*	Min distance C
60	4	~2.1	100	230 per metre of track	70
60	5	~2.3	120	230 per metre of track	80

*Stack size B when using optional extension arm SG 6364
 increases by 95 mm per curtain!

PARTS

A. STANDARD PARTS



SG 6053
Spring stop

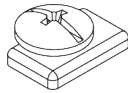

SG 11295
End stop



SG 6243p
Profile

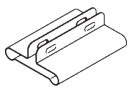

SG 7002
Profile protector (optional)



SG 0240
Countersunk head screw 2.2x19

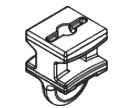

SG 11300
2C glider

B. OPTIONAL PARTS

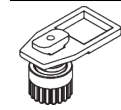

SG 2256
Brake

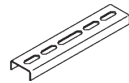

SG 3067
Connection bridge



SG 3582
Hook



SG 6064
End stop



SG 6094
Roller



SG 6098
Roller

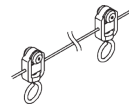

SG 6099
Wave roller cord 80 mm



SG 6283
Roller



SG 6349
Wave curtain tape



SG 6065
End stop



SG 11301
2C glider on strip

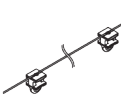

SG 11302
Wave 2C glider cord 80 mm

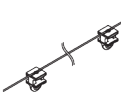

SG 11303
Wave 2C glider cord 60 mm